

Area & Perimeter

Name:

Period:

Date:

1.

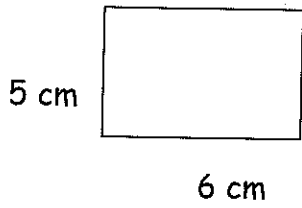

Area:

Perimeter:

2.

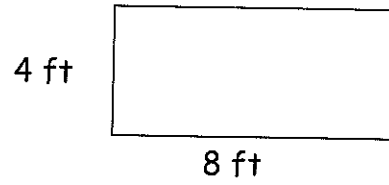

Area:

Perimeter:

3.

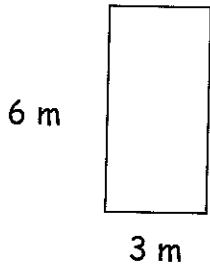

Area:

Perimeter:

4.

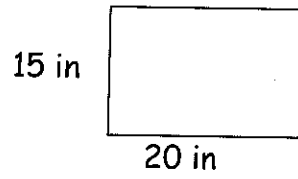

Area:

Perimeter:

5.

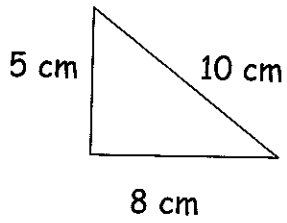

Area:

Perimeter:

6.

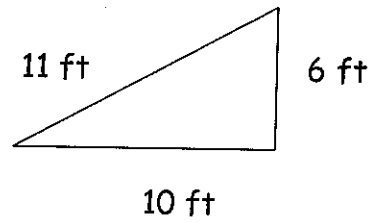

Area:

Perimeter:

7.

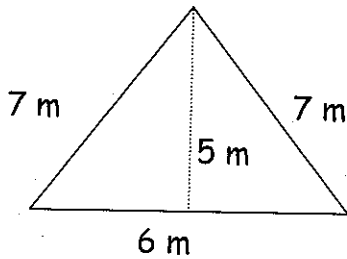

Area:

Perimeter:

8.

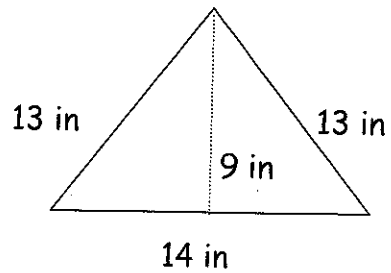

Area:

Perimeter:

9.

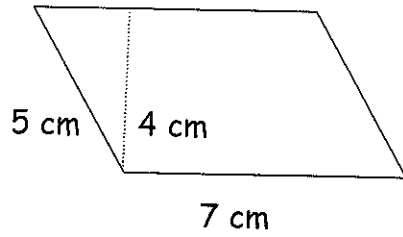

Area:
Perimeter:

10.

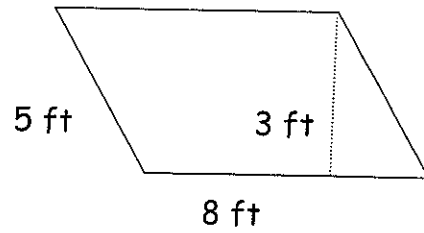

Area:
Perimeter:

11.

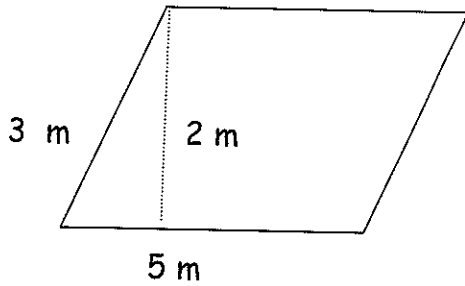

Area:
Perimeter:

12.

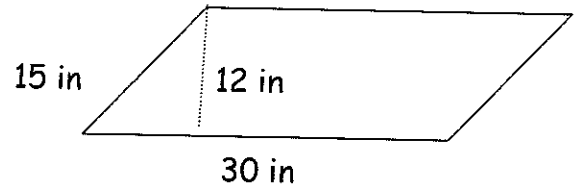

Area:
Perimeter:

13.

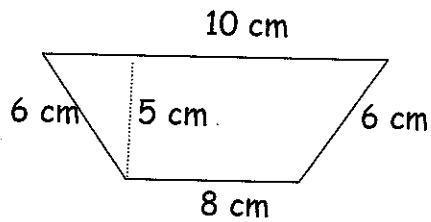

Area:
Perimeter:

14.

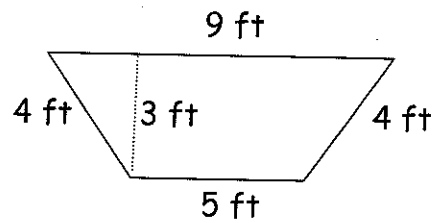

Area:
Perimeter:

15.

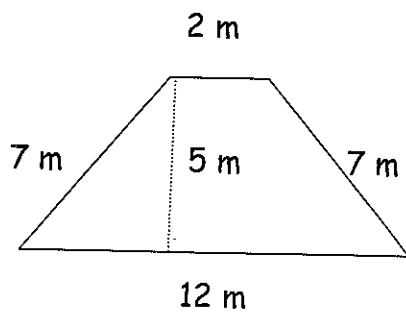

Area:
Perimeter:

16.

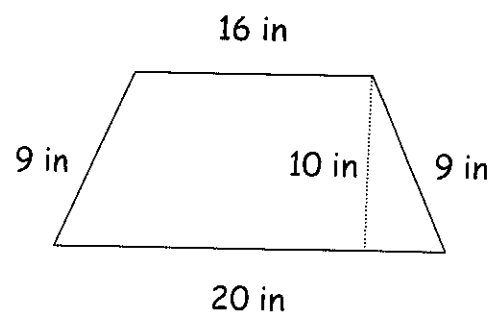

Area:
Perimeter: